

Instructions for combining shapes and cutting images in Adobe Illustrator

Instructions for combining shapes and cutting images in Adobe Illustrator. To create an illustration in Adobe Illustrator, you need to know the techniques of combining and cutting. This is one of the basic techniques that you will often use when designing. Please follow

To create an illustration in Adobe Illustrator, you need to know the techniques of combining and cutting. This is one of the basic techniques that you will often use when designing. Follow this article to learn how to combine photos and crop images in Adobe Illustrator.



Instructions for combining shapes and cutting images in Adobe Illustrator

In this article, you will be instructed on how to use the Shape Builder Tool to arrange the pieces into a complete pattern on the right. Please download the exercise file to be able to follow.

ket-hop-hinh-ai.zip

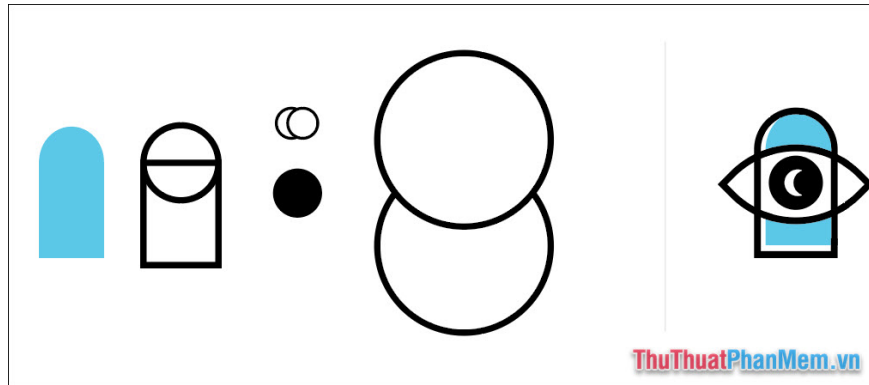

To combine these shapes, you first need to select them with the **Selection Tool** .



Drag and drop the mouse around the image to select all the content inside:

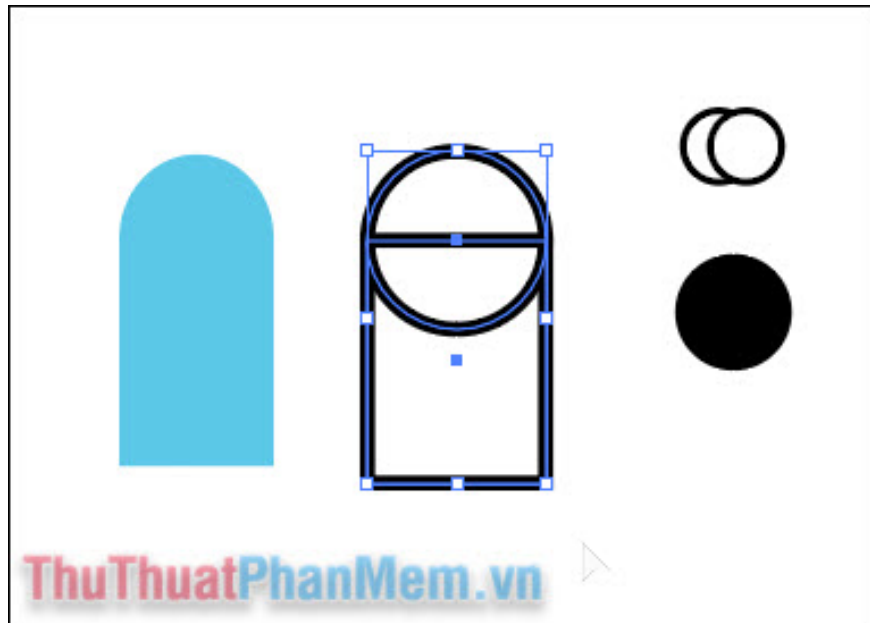
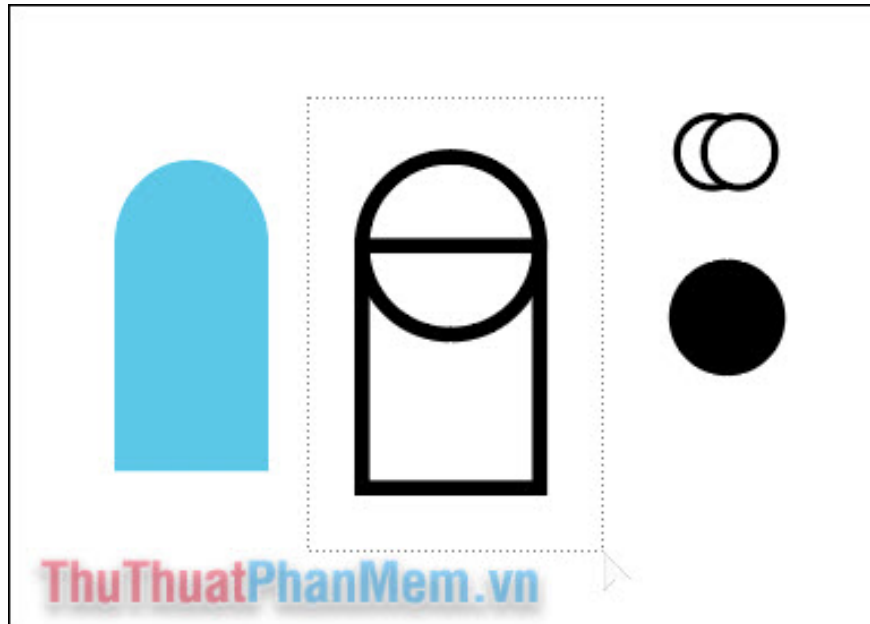

Select the **Shape Builder** tool (**Shift + M**) on the toolbar.

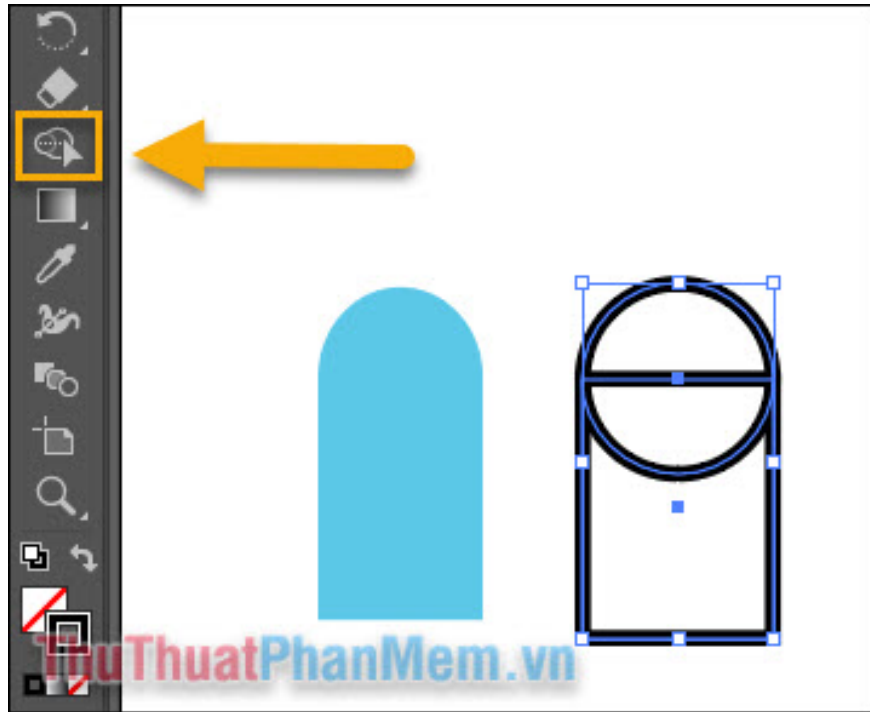

You drag and drop the mouse to draw any line going through the picture and they will be combined as follows:

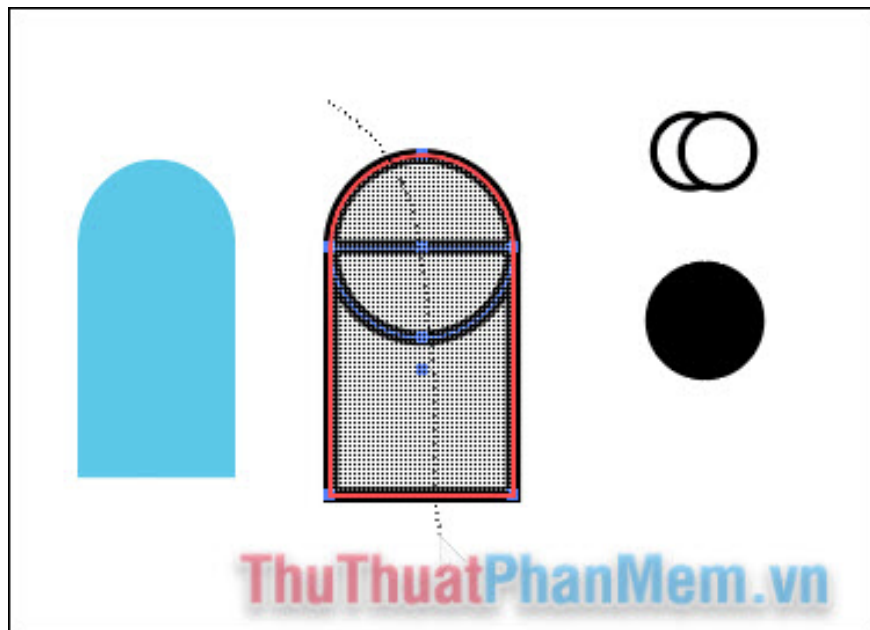

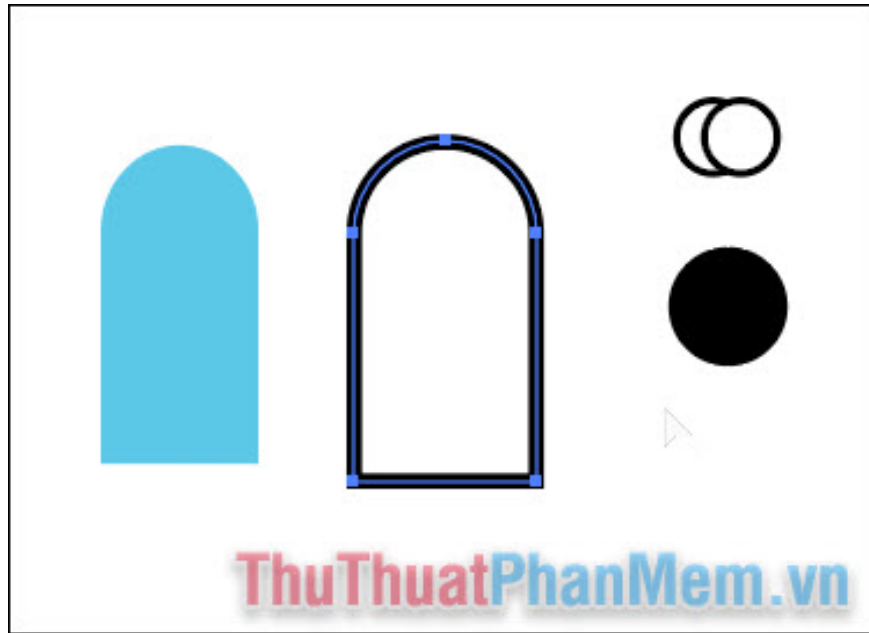

Next, you need to create an eye shape with the intersection of the two large circles. Continue using the **Selection Tool** to select them.

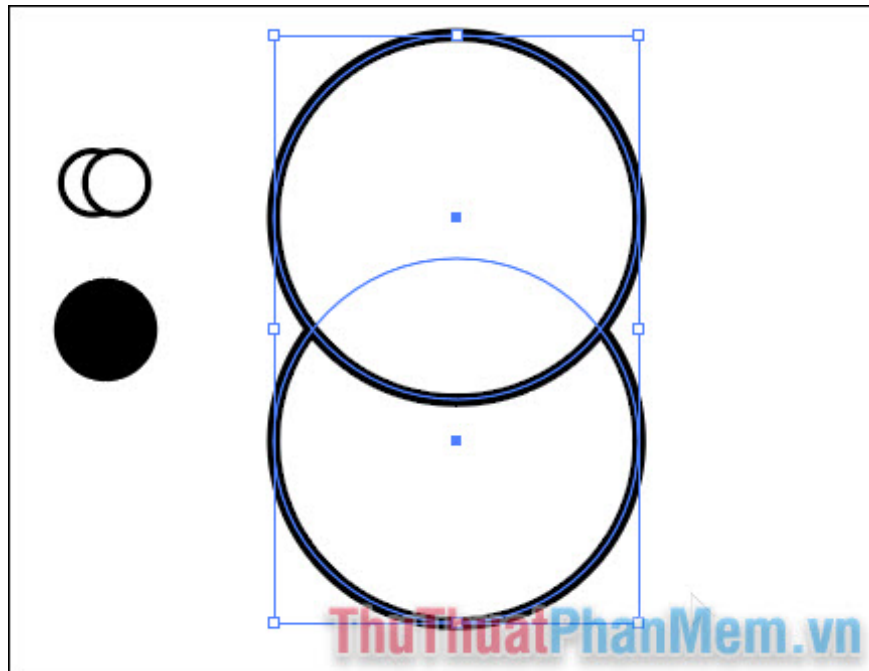

Switch to the **Shape Builder Tool** , to delete the leftovers, do the following:

Hold **Option** for **Mac** or **Alt** key for **Windows** . Then put the mouse pointer on the redundant, you will see a small minus sign next to the cursor. Then click on the rest of the image and remove them.

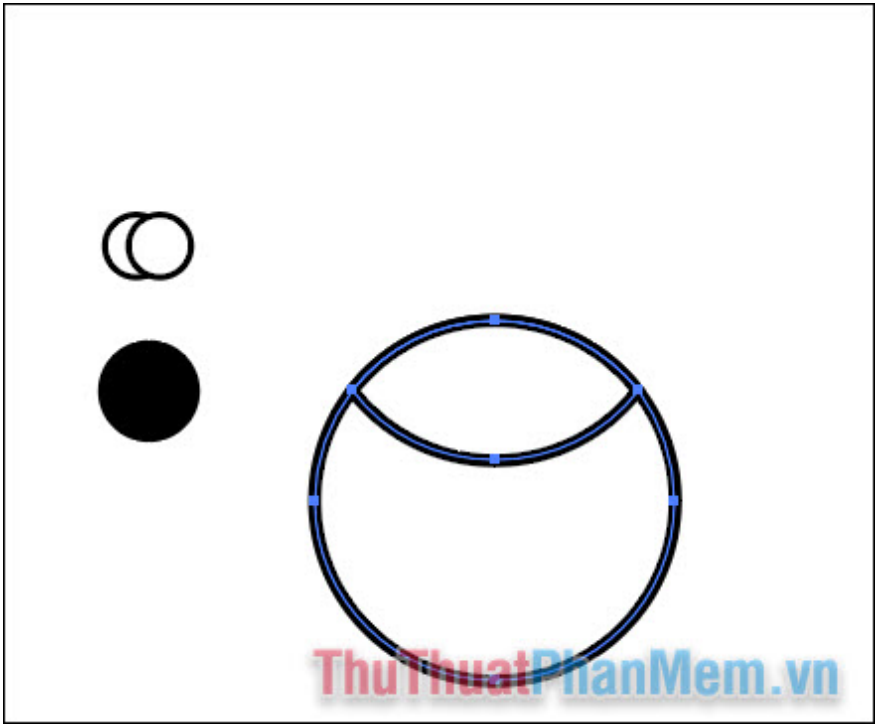
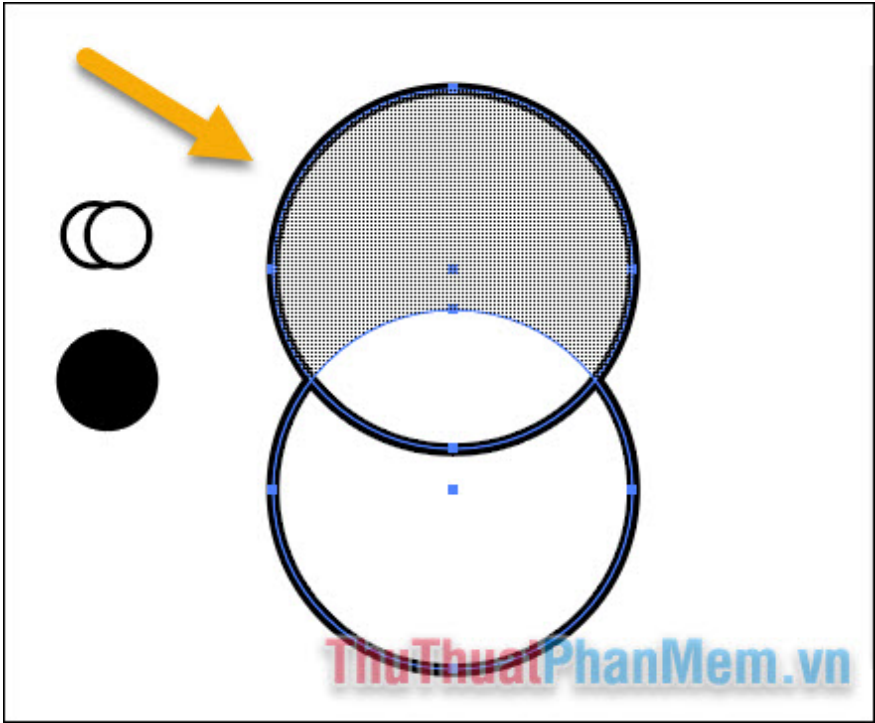

Do the same for the rest and you'll only have the intersection between the two circles.

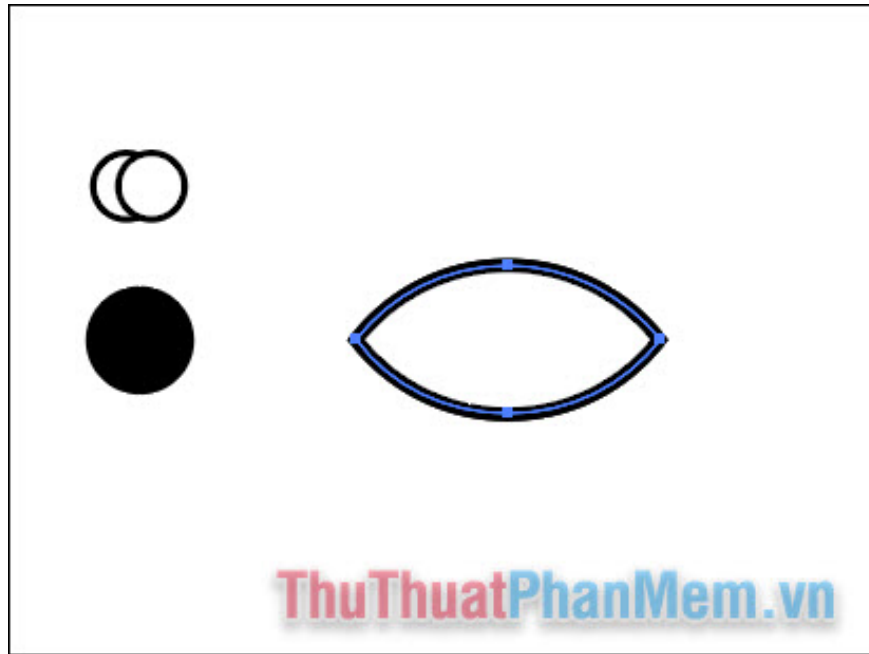

Next, use the **Selection Tool** to move the eye shape on the cylinder with drag and drop.

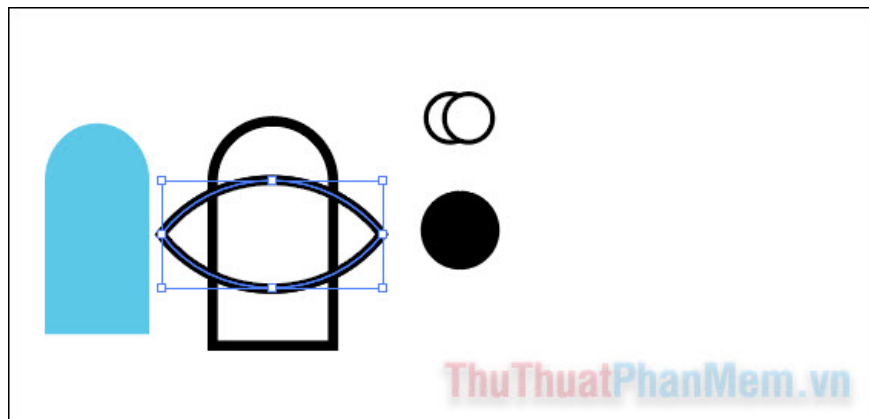
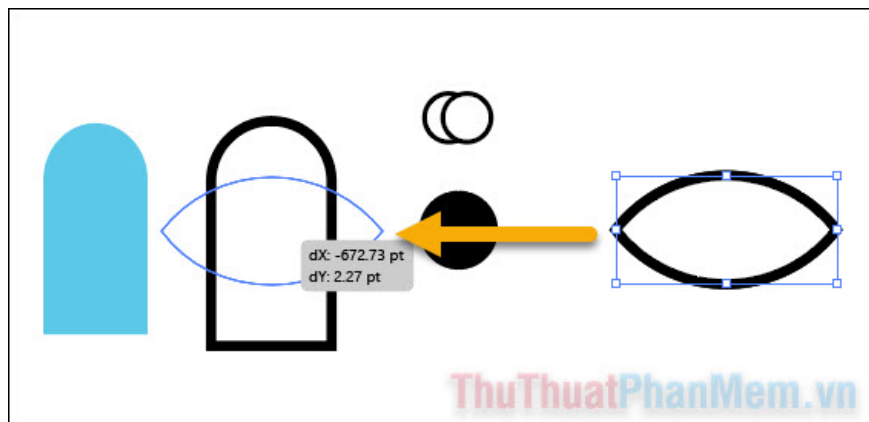

To cut the moon, pay attention to the two small circles placed on top of each other. Use the Selection Tool to select them.

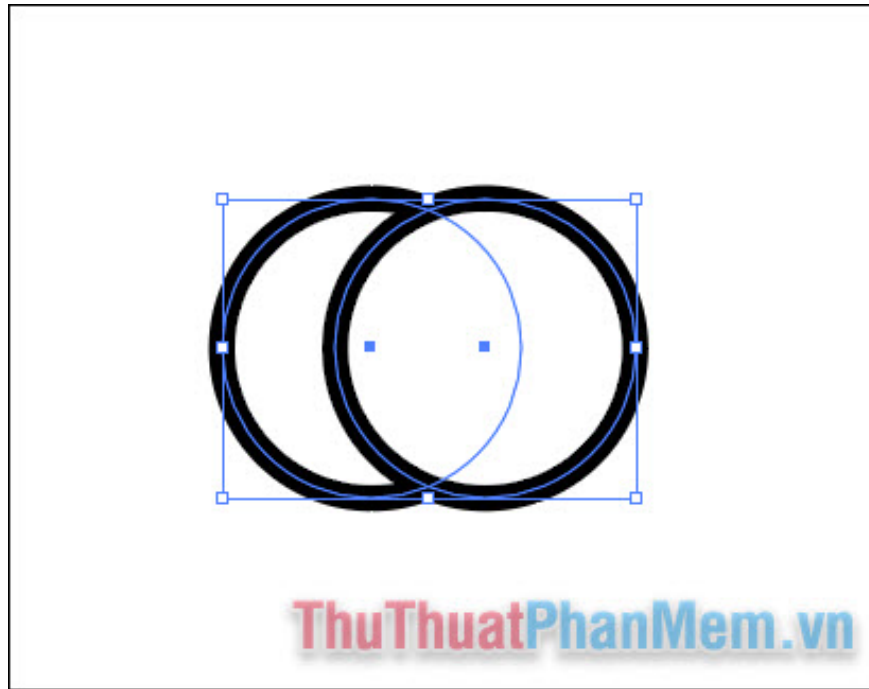

Pick the Shape Builder tool, hold **Alt** and let the cursor appear a minus sign, then drag a path through the parts you want to remove, then release the mouse. And your image has been cut.

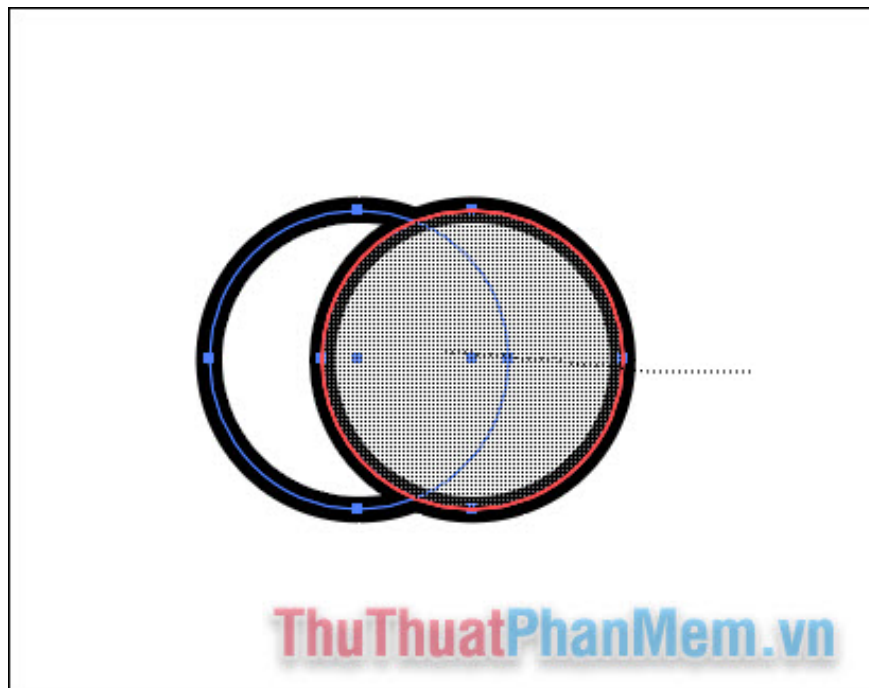

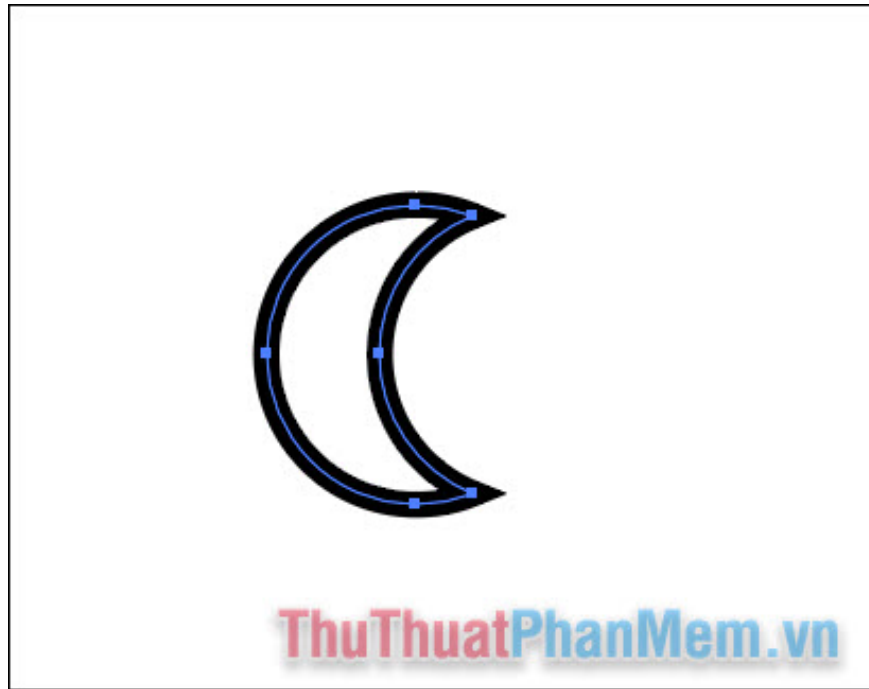

Use the **Selection Tool** to move the moon to a circular position with a black background.

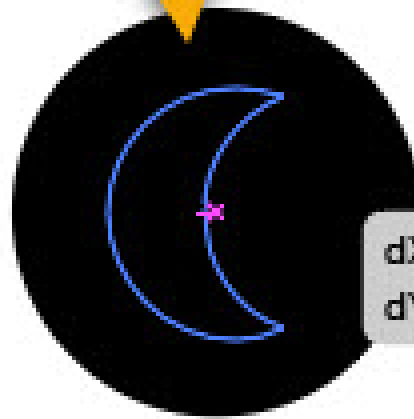
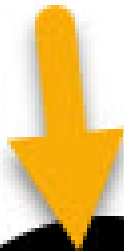
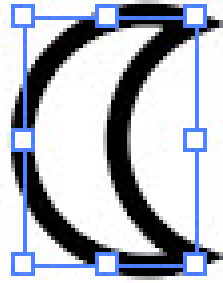

dX: 19.84 pt
dY: 165.06 pt

ThuThuatPhanMem.vn

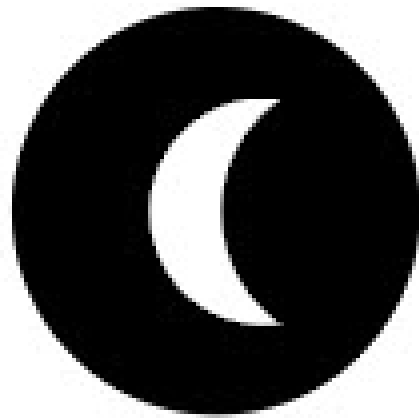

ThuThuatPhanMem.vn

Continue moving in the form:

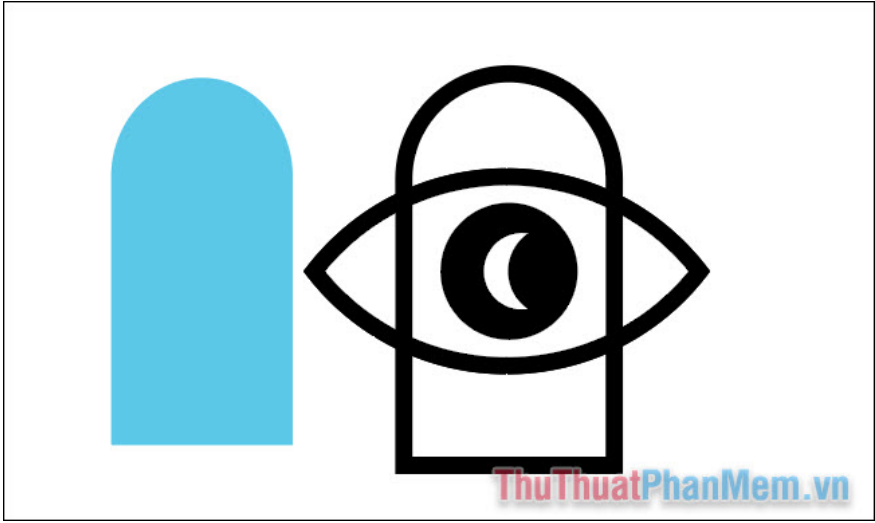
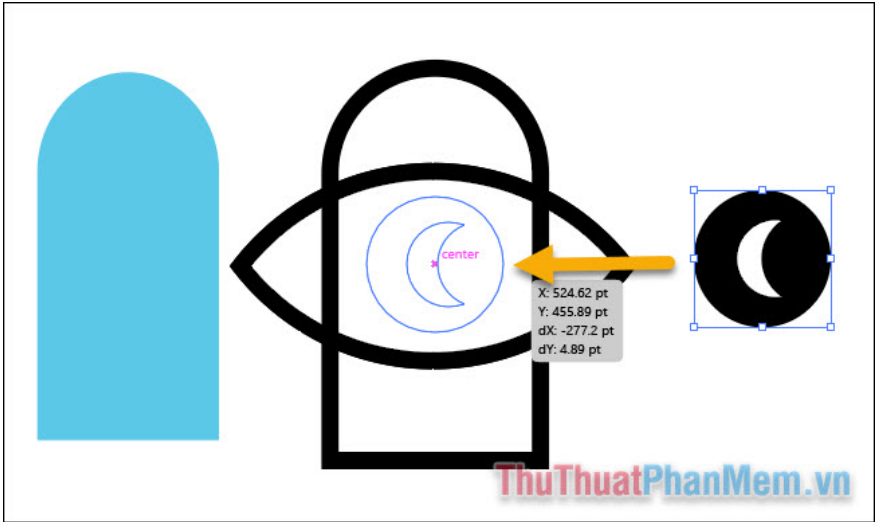

And finally the rest:

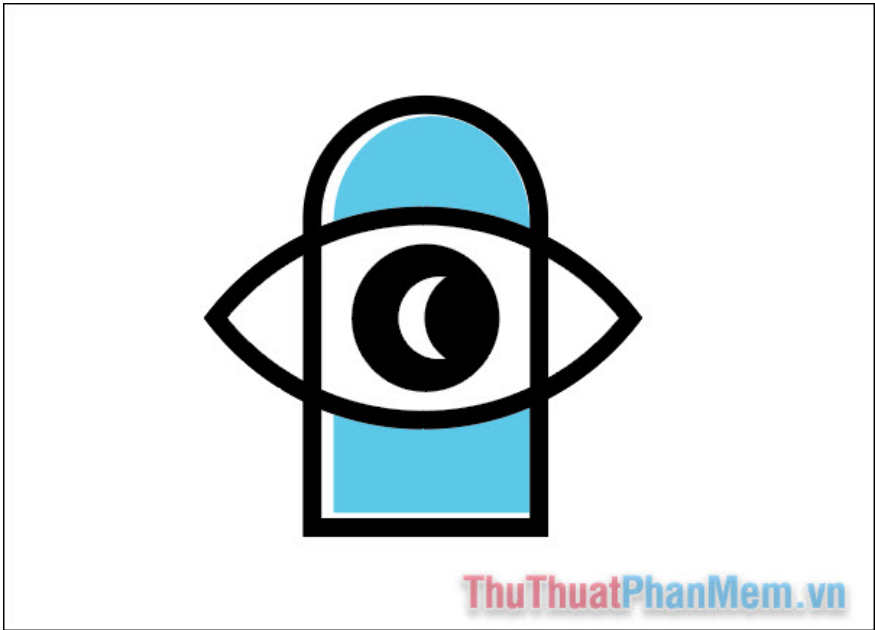

Thus, you have successfully performed the operations of combining and cutting images in Adobe Illustrator. Good luck!

You finished reading the article "**Instructions for combining shapes and cutting images in Adobe Illustrator**" edited by the [TipsMake](#) team. We hope this article has provided you with many useful tech tips and tricks. You can search for similar articles on tips and guides. Thank you for reading and for following us regularly.
